



SAME DAY SERVICE

LOWEST PRICES

HIGH QUALITY  
MATERIALS

**CATALOG OF REPLACEMENT PARTS FOR:**

**KOMORI**

**MANROLAND**



THIS CATALOG IS ONLY A SMALL SAMPLE OF OUR TOTAL INVENTORY.

WE ALSO CARRY REPLACEMENT PARTS FOR :

HEIDELBERG, A.B. DICK, CHIEF, DAVIDSON, GESTETNER, ITEK, HAMADA, MULTILITH,  
ROTAPRINT, RYOBI, TOWNSEND-51

**PRINTER'S REPAIR PARTS**

**2706 N EDGINGTON ST**

**FRANKLIN PARK, IL USA**

**TEL:1-847-288-9000 FAX 1-847-288-9010**

**WWW.PRINTERSREPAIRPARTS.COM EMAIL: PRPSALES@PRINTERSREPAIRPARTS.COM**

## KOMORI



### GRIPPER PADS

	<b>GRIPPER PAD</b> <b>P-112013</b>		<b>GRIPPER PAD</b> <b>P-112014</b>		<b>GRIPPER PAD</b> <b>P-112016</b>
	<b>GRIPPER PAD</b> <b>P-112017</b>		<b>GRIPPER PAD</b> <b>P-112018</b>		<b>GRIPPER PAD</b> <b>P-112019</b>
	<b>GRIPPER PAD</b> <b>P-112029</b>		<b>GRIPPER PAD</b> <b>P-112030</b>		<b>GRIPPER PAD</b> <b>P-112010</b>
	<b>GRIPPER PAD</b> <b>P-112011</b>		<b>GRIPPER PAD</b> <b>P-112021</b>		<b>GRIPPER PAD</b> <b>P-112022</b>





## KOMORI

### GRIPPERS

	<b>GRIPPER</b> <b>P-112007</b>		<b>GRIPPER PAD</b> <b>P-112008</b>		<b>GRIPPER</b> <b>P-112009</b>
	<b>GRIPPER</b> <b>P-112023</b>				<b>DELIVERY GRIPPER</b> <b>P-112012</b>

## KOMORI

### FORWARDING SUCKERS

	<b>FORWARDING SUCKER</b> <b>P-112003</b>		<b>FORWARDING SUCKER</b> <b>P-112004</b>
	<b>FORWARDING SUCKER</b> <b>P-112005</b>		<b>FORWARDING SUCKER</b> <b>P-112006</b>

## KOMORI



### SHEET PLATES

	<b>SHEET PLATE</b> <b>P-112024</b>		<b>SHEET PLATE</b> <b>P-112025</b>		<b>SHEET PLATE</b> <b>P-112026</b>
	<b>SHEET PLATE</b> <b>P-112027</b>		<b>SHEET PLATE</b> <b>P-112028</b>		

## KOMORI



### MISCELLANEOUS PRODUCTS

	<b>CAM FOLLOWER</b> <b>P-112000</b>		<b>BRUSH PAIR</b> <b>P-112001</b>
	<b>HICKEY WIPER</b> <b>P-112002</b>		<b>BRUSH</b> <b>P-112020</b>

## MANROLAND



### GRIPPER PADS









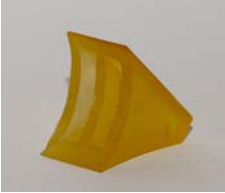

	<b>GRIPPER PAD</b> <b>P-110000</b>		<b>GRIPPER PAD</b> <b>P-110001</b>		<b>GRIPPER PAD</b> <b>P-110002</b>
	<b>GRIPPER PAD</b> <b>P-110003</b>		<b>GRIPPER PAD</b> <b>P-110004</b>		<b>GRIPPER PAD</b> <b>P-110005</b>
	<b>GRIPPER PAD</b> <b>P-110006</b>		<b>GRIPPER PAD</b> <b>P-110007</b>		<b>GRIPPER PAD</b> <b>P-110008</b>
	<b>GRIPPER PAD</b> <b>P-110009</b>		<b>GRIPPER PAD</b> <b>P-110010</b>		<b>GRIPPER PAD</b> <b>P-110011</b>
	<b>GRIPPER PAD</b> <b>P-110012</b>		<b>GRIPPER PAD</b> <b>P-110013</b>		<b>GRIPPER PAD</b> <b>P-110014</b>
	<b>GRIPPER PAD</b> <b>P-110016</b>		<b>GRIPPER PAD</b> <b>P-110017</b>		<b>GRIPPER PAD</b> <b>P-110018</b>
			<b>GRIPPER PAD</b> <b>P-110019</b>		

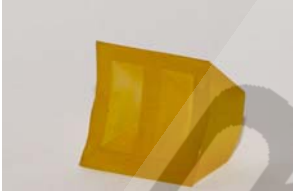

## MANROLAND

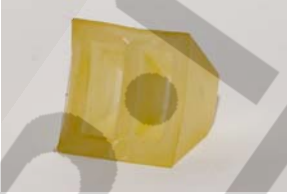





### GRIPPER PADS

	<b>GRIPPER PAD</b> P-110040		<b>GRIPPER PAD</b> P-110041		<b>GRIPPER PAD</b> P-110042
	<b>GRIPPER PAD</b> P-110043		<b>GRIPPER PAD</b> P-110044		<b>GRIPPER PAD</b> P-110045
			<b>GRIPPER PAD</b> P-110046		
	<b>GRIPPER PAD</b> P-110047		<b>GRIPPER PAD</b> P-110048		<b>GRIPPER PAD</b> P-110049

## MANROLAND











### FORWARD SUCKERS

	<b>FORWARD SUCKER</b> P-110021		<b>FORWARD SUCKER</b> P-110022		<b>FORWARD SUCKER</b> P-110023		<b>FORWARD SUCKER</b> P-110024
------------------------------------------------------------------------------------	-----------------------------------	-------------------------------------------------------------------------------------	-----------------------------------	--------------------------------------------------------------------------------------	-----------------------------------	---------------------------------------------------------------------------------------	-----------------------------------

## MANROLAND





### INK DUCT END BLOCKS

	<b>INK DUCT END BLOCK</b> P-110032		<b>INK DUCT END BLOCK</b> P-110033		<b>INK DUCT END BLOCK</b> P-110034		<b>INK DUCT END BLOCK</b> P-110035
	<b>INK DUCT END BLOCK</b> P-110036		<b>INK DUCT END BLOCK</b> P-110037		<b>INK DUCT END BLOCK</b> P-110038		<b>INK DUCT END BLOCK</b> P-110039

## MANROLAND



### CAM FOLLOWERS

	<b>CAM FOLLOWER</b> P-110025		<b>CAM FOLLOWER</b> P-110026		<b>CAM FOLLOWER</b> P-110027
------------------------------------------------------------------------------------	---------------------------------	-------------------------------------------------------------------------------------	---------------------------------	---------------------------------------------------------------------------------------	---------------------------------

## MANROLAND



### CARRIER LINKS

	<b>CARRIER LINK</b> P-8720		<b>CARRIER LINK</b> P-110052		<b>CARRIER LINK</b> P-110053
------------------------------------------------------------------------------------	-------------------------------	-------------------------------------------------------------------------------------	---------------------------------	---------------------------------------------------------------------------------------	---------------------------------

## MANROLAND



### DELIVERY GRIPPERS

	<b>DELIVERY GRIPPER</b>  <b>P-110028</b>		<b>DELIVERY GRIPPER</b>  <b>P-110029</b>
	<b>DELIVERY GRIPPER</b>  <b>P-110030</b>		<b>DELIVERY GRIPPER</b>  <b>P-110031</b>

## MANROLAND



### FEEDER WHEELS

	<b>FEEDER WHEEL</b>  <b>P-110054</b>		<b>FEEDER WHEEL</b>  <b>P-110055</b>		<b>FEEDER WHEEL</b>  <b>P-110056</b>
	<b>FEEDER WHEEL</b>  <b>P-110057</b>		<b>FEEDER WHEEL</b>  <b>P-110058</b>		<b>FEEDER WHEEL</b>  <b>P-110059</b>



## MANROLAND





### FEEDER BRUSHES

	<b>FEEDER BRUSH</b> P-110060		<b>FEEDER BRUSH</b> P-110061		<b>FEEDER BRUSH</b> P-110062
	<b>FEEDER BRUSH</b> P-110063		<b>FEEDER BRUSH</b> P-110064		<b>FEEDER BRUSH</b> P-110065

## MANROLAND



### SHEET SEPARATOR

	<b>SHEET SEPARATOR</b> P-110067		<b>SHEET SEPARATOR</b> P-110068		<b>SHEET SEPARATOR</b> P-110069
------------------------------------------------------------------------------------	------------------------------------	-------------------------------------------------------------------------------------	------------------------------------	---------------------------------------------------------------------------------------	------------------------------------

## MANROLAND



### MISCELLANEOUS PRODUCTS

	<b>SHEET SLOW DOWN BELT</b> P-110066		<b>PUMP FILTER</b> P-110070		<b>PUMP FILTER</b> P-110071
-------------------------------------------------------------------------------------	-----------------------------------------	-------------------------------------------------------------------------------------	--------------------------------	---------------------------------------------------------------------------------------	--------------------------------



**SE HABLA ESPANOL  
A GENTE FALA PORTUGUES**



**REPLACEMENT PARTS FOR A.B. DICK \* CHIEF \* DAVIDSON  
\* GESTETNER \* HAMADA \* HEILDELBERG \* ITEK \* KOMORI  
\* MANROLAND \* MULTILITH \* ROTAPRINT \* RYOBI \* T-51**